

DENAR® PARTS LIST

MARK 320
20011384

PART #: 20011574
EFFECTIVE: 7-1-2020
SUPERSEDES: 3-1-2020

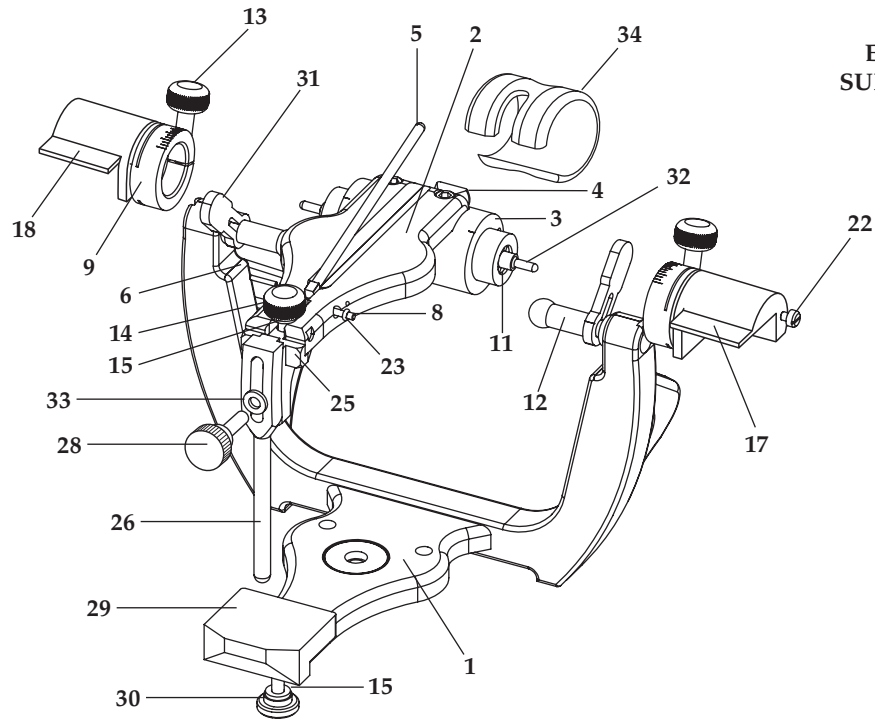

Key #	Part #	Description
1		Lower Sub-assembly*
2		Upper Bow*
3		Pivot Bar*
4		Latch*
5		Support Pin*
6		Pin, Spring*
8	20011013	Lockpin, Support
9		Fossa*
11		Latch Pin Screw*
12		Ball/Shaft, Condyle*
13	20011018	Lock Knob, Fossa
14, 15	110087	Incisal Pin Knob
15	3631	Nylon Washer
17	20011104	Medial Wall, left
18	20011103	Medial Wall, right
22	3771	Screw, Shoulder

Key #	Part #	Description
23	20011289	O-Ring
25, 26, 28	20011386	Incisal Pin with Support Assembly
25		Incisal Support*
26		Incisal Pin*
28	110085	Screw Assembly (Knob, Screw & Washer)
29, 30	110240	Incisal Table Assembly
29	110159-2	Incisal Table
30	110084	Knob Screw Assembly
31	20011290	Elastic Retainer
32		Centric Pin*
33	3062	Washer
34	20011392	Mark 300 Series Dust Cover

* Factory Repair Required



RESTORATIVE ORAL HEALTH
Whip Mix Corporation
361 Farmington Avenue
Louisville, KY USA 40209
Toll-Free: 800-626-5651
Fax: 502-634-4512
www.whipmix.com